

REMINGTON®

EP3 3-IN-1 EPILATOR



EP7300

 remington-europe.com

Register online for an EXTRA year guarantee

Visit www.remington.co.uk/productregister. You must register within 28 days of purchase.

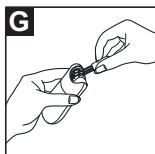
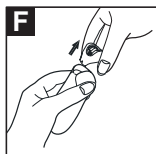
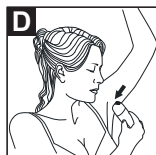
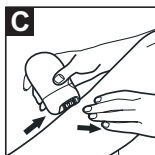
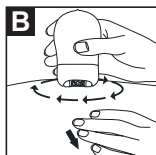
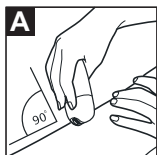
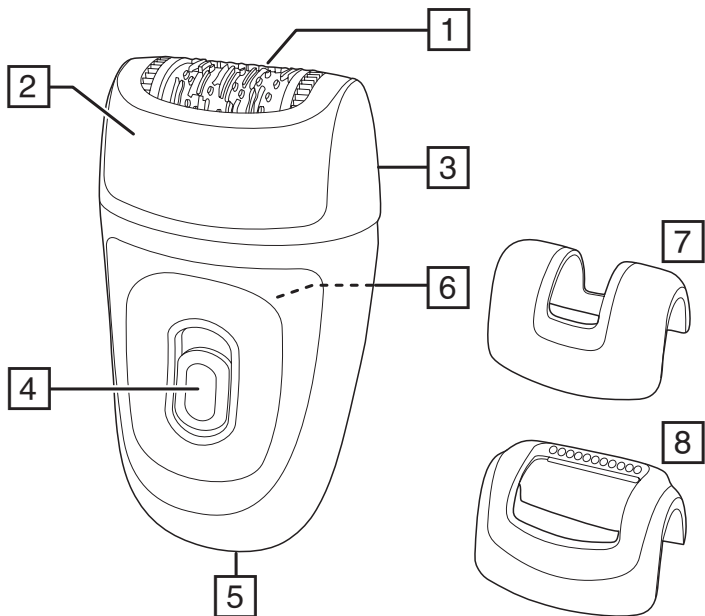

Thank you for buying your new Remington® product. Please read these instructions carefully and keep them safe. Remove all packaging before use.

IMPORTANT SAFEGUARDS

- This appliance can be used by children aged from 8 years and above and persons with reduced physical, sensory or mental capabilities or lack of experience and knowledge if they have been supervised/instructed and understand the hazards involved. Children shall not play with the appliance. Cleaning and user maintenance shall not be done by children unless they are older than 8 and supervised. Keep the appliance and cable out of reach of children under 8 years.
- **WARNING:** Keep the appliance dry.
- Do not use the product with a damaged cord. A replacement can be obtained via our International Service Centres.
- Do not use the appliance if it is damaged or malfunctions.
- Do not use attachments other than those we supply.
- Do not leave the appliance unattended while plugged in.
- Keep the power plug and cord away from heated surfaces.
- Make sure the power plug and cord do not get wet.
- Do not plug or unplug the appliance with wet hands.
- Do not twist or kink the cable, or wrap it round the appliance.
- This appliance is not intended for commercial or salon use.

PARTS

- | | |
|--------------------------------|-------------------------------|
| 1. Tweezers | 6. Head Release Button |
| 2. Ultimate Contour Cap | 7. Detail Cap |
| 3. Removable and Washable Head | 8. Massage Cap with Aloe Vera |
| 4. On/Off Switch – 2 Speeds | 9. Cleaning Brush (not shown) |
| 5. Power Connection | 10. Mains Adaptor (not shown) |

GENERAL INFORMATION ON EPILATION

The rotating tweezers catch even short hairs and pull them out by the root. The hairs that grow back are soft and thin. Epilating leaves your skin smooth and hair-free for several weeks. If you have not used an epilator before, or if you have not epilated for a long period of time, it may take a short while for your skin to adapt to epilation. The discomfort experienced at first is considerably reduced with repeated use as the skin adjusts to the process.

Using an epilator may cause reddening or irritation of the skin. This is a normal reaction that will quickly disappear. However, you should consult your doctor if the irritation has not disappeared within three days.

All methods of hair removal from the root can result in in-growing hair depending on the condition of the skin and hair. Regular exfoliation helps to prevent in-growing hair.

In some cases inflammation of the skin could occur when bacteria penetrate the skin (e.g. when moving the appliance over the skin). Thorough cleaning of the epilation head before each use will minimise the risk of infection.

INSTRUCTIONS FOR USE

USEFUL TIPS

- When using an epilator for the first time it is best to try it on a small area to get used to the process of epilation.
- The optimum length for hair removal is between 2-5mm. Epilation is easier and more comfortable.
- Take a warm bath or shower before epilating and exfoliate to remove dead skin cells.
- This will make your skin more pliable, making the epilation process less uncomfortable.
- Epilate in the evening so that any possible reddening can disappear overnight.
- After use you can use a body cream or aloe lotion to soothe the skin and reduce skin irritation.
- Exfoliate regularly to avoid in-growing hair.

EXFOLIATE

- Exfoliation prevents in-growing hairs. Ingrown hairs occur when the growing hair curls up under the skin instead of growing out like it should. It results in an often painful red bump and possible infection. Rubbing your skin with an exfoliation glove in the shower or bath, or using a dry body brush will help reduce ingrown hairs or infections.
- Before epilating ensure the skin is clean, dry and free from creams or oils.
- Rub the skin in the area to be epilated to lift short hairs to optimise hair removal.
- Ensure the Epilator is OFF and attach the power cord to the product and then to the mains.

USING THE EPILATOR

1. Turn the epilator on to the desired speed:
 - **LOW is recommended for fine hair**

- **HIGH is recommended for coarse hair or stronger hair growth**
- 2. Using your free hand, hold the skin taut to make the hairs stand upright.
- 3. Position the epilator flat so that the tweezers are at a 90° angle and flat against the skin. The Ultimate Contour Cap will ensure the optimum tweezing angle (Figure A).
- 4. Using small circular motions, slowly and gently glide the epilator over the skin. This circular motion is the most effective method and makes the process less uncomfortable (Figure B).
- 5. Alternatively, guide the epilator in a slow, continuous movement against the hair growth.
- 6. Repeat within each area until all unwanted hair is removed.
- 7. After epilating, turn the epilator off.

ARM/LEG EPILATION

Epilate from the lower arm/leg and slowly move upwards. To epilate behind the elbow/knee, keep the arm/leg straight to stretch the skin (Figure C).

UNDERARMS AND BIKINI

Please be aware that these areas are particularly sensitive. However this sensitivity will reduce after repeated usage. For more comfort, ensure that the skin is held taut and that the hair is at the optimum length of 2-5mm. If it has been an extended period of time since you have removed hair, trim the hair with a Remington® bikini trimmer or cosmetic trimmer before epilation (Figure D and E).

It is recommended to use LOW speed or Detail cap for these sensitive areas.

FACIAL EPILATION

- Use the Detail Cap.
- Place epilator at a 90° angle to the skin and move the epilator head in a circular motion.
- **NOTE:** Do not use for removing hair from the eyebrow.
- Keep the product away from hair on the scalp, eyebrows and eyelashes.

DETAIL CAP

- The detail cap is designed for small areas (including the face) and spot treatments.
- Ensure the epilator is switched off.
- Remove the Ultimate Contour or Massage Cap.
- Place the Detail Cap into the appropriate slots at the top of the epilator.
- Gently press the Detail Cap into place until you hear a "click".

MESSAGE CAP WITH ALOE VERA

- The Massage Cap is designed for gentler epilation.
- Ensure the epilator is switched off.
- Remove the Ultimate Contour or Detail Cap.
- Place the Massage Cap into the appropriate slots at the top of the epilator.
- Gently press the Detail Cap into place until you hear a "click".

CAUTION

- For your protection your epilator may slow down or even stop if pressed too firmly against the skin.

- Do not use the epilating head on irritated skin or skin with varicose veins, rashes, spots, moles or wounds without consulting a doctor. People with reduced immune response e.g. during pregnancy, or people who suffer from diabetes mellitus, haemophilia or immunodeficiency should also consult their doctor before using this product.
- For hygiene reasons do not let another person use your epilator. It is recommended for use by one person only.

CLEANING AND MAINTENANCE

To ensure long lasting performance of your epilator, clean the head assembly regularly.

Cleaning the epilator head after each use:

1. Ensure the epilator is turned off and disconnected from the mains.
2. Press the head release button and open the head assembly (Figure F).
3. Turn the head assembly upside down.
4. The epilator head can be removed and rinsed for cleaning. For optimal cleaning; brush hairs from the tweezers before rinsing (Figure G).
5. Allow to dry completely before reattaching the cap.

NOTE: The body of the epilator is not washable. The epilator head must be removed prior to rinsing under water. DO NOT SUBMERGE IN WATER.

To remove residue:

- To remove residue from the stainless steel tweezers, dampen a swab with alcohol.
- Gently run the swab over the tweezers until the residue has been removed.

CAUTION: Make sure that the cotton swab is not soaked in alcohol as this may damage the epilator.

ADAPTER SPECIFICATIONS

Manufacturer address and registration number	Spectrum Brands (UK) Limited, Regent Mill, Fir Street, Failsworth, Manchester M35 0HS Company number: 02394603
Adapter model number	SW-120060BS
Input voltage	100 - 240 V~
Input AC Frequency	50/60Hz
Output voltage	12.0 V ===
Output current	0.6 A
Output power	7.2 W
Average active efficiency	≥80.01%
Efficiency at 10%	-
No load power consumption	≤0.1W

RECYCLING



To avoid environmental and health problems due to hazardous substances, appliances and rechargeable and non-rechargeable batteries marked with one of these symbols must not be disposed of with unsorted municipal waste. Always dispose of electrical and electronic products and, where applicable, rechargeable and non-rechargeable batteries, at an appropriate official recycling/collection point.

SERVICE AND GUARANTEE



Defects affecting product functionality appearing within the guarantee period will be corrected by replacement or repair at our option provided the product is used and maintained in accordance with the instructions. Your statutory rights are not affected.

This warranty shall not be valid where it is contrary to U.S. and other applicable laws, or where the warranty would be prohibited under any

economic sanctions, export control laws, embargos, or other restrictive trade measures enforced by the United States or other applicable jurisdictions. This includes, without limitation, any warranty claims implicating parties from, or otherwise located in, Cuba, Iran, North Korea, Syria and the Crimea region.

To claim an extra 1 year guarantee, register your product online within 28 days of purchase.

Register at: <https://uk.remington-europe.com/product-registration>

Consumables are guaranteed only for their recommended lifecycle. Replacement/spare parts* are excluded and are only covered by a 1 year warranty.

*Examples include, but are not limited to, adaptors, haircare attachments, grooming accessories, etc.

SERVICE CENTRE

UNITED KINGDOM

☎ 0800 212 438 (free call mainland UK)

Spectrum Brands (UK) Ltd
Fir Street, Failsworth, Manchester
M35 0HS, UK

www.remington.co.uk
productsupport@Remington.co.uk

*You must register within 28 days of purchase.

IRELAND

☎ 142 951 40

Remington Consumer Products,
Unit B12, Ballymount Corporate Park,
Ballymount, Dublin 12

<https://ie.remington-europe.com>
productsupport@Remington.co.uk

Ref. No. EP7300

Type No. EP7010

20/UK/EP7300 T22-7001744 Version 08 /20

Remington® is a Registered Trade Mark of Spectrum Brands, Inc., or one of its subsidiaries.

Spectrum Brands (UK) Ltd

Fir Street,

Failsworth,

Manchester

M35 0HS

remington-europe.com

© 2020 Spectrum Brands, Inc.