

REMINGTON®

EST. NEW YORK 1937



Botanicals™ Straightener S5860

 www.remington.co.uk

Register online for an EXTRA year guarantee

Visit uk.remington-europe.com/product-registration You must register within 28 days of purchase.

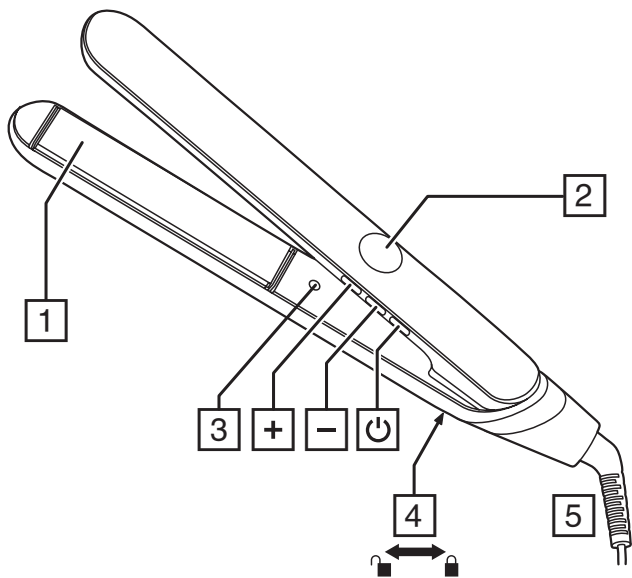

Thank you for buying your new Remington® product. Please read these instructions carefully and keep them safe. Remove all packaging before use.

WARNING: This appliance is hot. Keep out of reach of children at all times.

IMPORTANT SAFEGUARDS

- This appliance can be used by children aged from 8 years and above and persons with reduced physical, sensory or mental capabilities or lack of experience and knowledge if they have been supervised/instructed and understand the hazards involved. Children shall not play with the appliance. Cleaning and user maintenance shall not be done by children unless they are older than 8 and supervised. Keep the appliance and cable out of reach of children under 8 years.
 -  Do not use this appliance near bathtubs, showers, basins or other vessels containing water.
 - When the appliance is used in a bathroom, unplug it after use since the proximity of water presents a hazard even when the appliance is switched off.
 - For additional protection, the installation of a residual current device (RCD) having a rated residual operating current not exceeding 30 mA is advisable in the electrical circuit supplying the bathroom*.
- * Currently, the fitting in a bathroom of an electrical socket suitable or capable of operating the appliance is not permitted in the UK (see BS7671).
- Burn hazard. Keep the appliance out of reach from young children, particularly during use and while cooling down.
 - Never leave the appliance unattended when it is connected to the power supply.
 - Always place the appliance with its stand, if any, on a heat-resistant, stable flat surface.

- If the supply cord of this unit becomes damaged, discontinue use immediately and return the appliance to your nearest authorised Remington® service dealer for repair or replacement in order to avoid a hazard.
- Do not allow any part of the appliance touch the face, neck or scalp.
- Keep the power plug and cord away from heated surfaces.
- Do not use attachments other than those we supply.
- Do not use the appliance if it is damaged or malfunctions.
- Do not twist or kink the cable, or wrap it round the appliance. Check the cord regularly for any signs of damage.
- CAUTION: Always remove the appliance from the storage pouch/sleeve before heating and allow it to fully cool before placing it back.
- This appliance is not intended for commercial or salon use.

PARTS

- | | |
|-----------------------------------|---------------------------|
| 1. Advanced ceramic coated plates | Controls: |
| 2. Display | ⏻ On/off button |
| 3. Ion emitter | +/- Temperature functions |
| 4. Hinge lock | Accessories (not shown): |
| 5. Swivel cord | • Storage pouch |
-

ADDITIONAL FEATURES

- Fast heat up—ready to use in 15 seconds.
 - Automatic safety shut off – this unit will switch itself off if no button is pressed or it is left on after 60 minutes.
 - Multivoltage: for home or abroad. At 120V times and temperatures may vary.
-

INSTRUCTIONS FOR USE

- Before use, ensure the hair is clean, dry and tangle-free.
- For extra protection use a heat protection spray.
- Hairsprays contain flammable material - do not use while using this product.
- Section the hair prior to styling. Style the lower layers first.
- 1. Plug the product into the mains power supply.
- 2. When your straightener is plugged in but not turned on the lock symbol  will come on to show that it is in standby mode.

- Press and hold the on/off button to switch on .
- Start styling on lower temperatures first. Select the appropriate temperature for your hair type using the controls on the side of the product. '+' increases the temperature '-' decreases the temperature.

Recommended Temperatures

Temperature	Hair type
150°C - 170°C	Thin / fine, damaged or bleached hair
180°C - 200°C	Normal, healthy hair
210°C - 230°C	Thick, very curly and difficult to style hair

- Caution:** the hottest temperatures should only be used by experienced stylists
- The digital display will stop flashing when the product is ready to use.
 - Working on one section at a time, run the straightener through the entire length of the hair without stopping.
 - After use, press and hold the on/off () button for two seconds to turn off then unplug the appliance.

Botanicare Setting

- The BotaniCare setting gently styles the hair at 185°C.
- To activate press and hold '+' for 2 seconds,  will appear on the display.

Ionic Conditioning

- During styling negative ions are released onto the hair actively reducing static for smooth, sleek results.
- It is normal for the product to create a low buzzing noise while in use as the ions are created.

Temperature Lock Function

- Set the desired temperature using the + and - buttons then lock the settings by pressing the "—" button for 2 seconds. The  symbol will appear on the temperature display.
- To unlock the temperature setting, press and hold the "—" button for 2 seconds.

Memory Function

- Each time you use your styler it will automatically set itself to the last setting used.

STORAGE, CLEANING AND MAINTENANCE

Let the appliance cool down before cleaning and storing away

- Wipe all the surfaces with a damp cloth.
- Don't use harsh or abrasive cleaning agents or solvents.

The plates can be locked together for easy storage:

To lock, close the plates and slide the hinge lock to the locked  position.

To unlock, slide the hinge lock to the unlocked  position.

NOTE: Do not heat the unit in the locked position.

RECYCLING



To avoid environmental and health problems due to hazardous substances, appliances and rechargeable and non-rechargeable batteries marked with one of these symbols must not be disposed of with unsorted municipal waste. Always dispose of electrical and electronic products and, where applicable, rechargeable and non-rechargeable batteries, at an appropriate official recycling/collection point.

SERVICE AND GUARANTEE



Defects affecting product functionality appearing within the guarantee period will be corrected by replacement or repair at our option provided the product is used and maintained in accordance with the instructions. Your statutory rights are not affected. To claim an extra 1 year guarantee, register your product online within 28 days of purchase.

This warranty shall not be valid where it is contrary to U.S. and other applicable laws, or where the warranty would be prohibited under any economic sanctions, export control laws, embargos, or other restrictive trade measures enforced by the United States or other applicable jurisdictions. This includes, without limitation, any warranty claims implicating parties from, or otherwise located in, Cuba, Iran, North Korea, Syria and the Crimea region.

Register at: <https://uk.remington-europe.com/product-registration>

Consumables are guaranteed only for their recommended lifecycle. Replacement/spare parts* are excluded and are only covered by a 1 year warranty.

*Examples include, but are not limited to, adaptors, haircare attachments, grooming accessories, etc.

SERVICE CENTRE

United Kingdom

 0800 212 438 (free call mainland UK)

Spectrum Brands (UK) Ltd

Fir Street, Failsworth, Manchester

M35 0HS, UK

www.remington.co.uk

Product support:

productsupport@remington.co.uk

Ireland

 142 951 40

Remington Consumer Products,

Unit B12, Ballymount Corporate Park,

Ballymount, Dublin 12

<https://ie.remington-europe.com>

Product support:

productsupport@remington.co.uk

Ref. No. S5860

Type No. S32A

22/UK/ S5860 T22-7002516 Version 01 /22

Remington® is a Registered Trade Mark of Spectrum Brands, Inc., or one of its subsidiaries.

Spectrum Brands (UK) Ltd

Fir Street,

Failsworth,

Manchester

M35 0HS

remington-europe.com

© 2022 Spectrum Brands, Inc.